

# Ambientes *Environments*



# Colaborativo *Collaborative*

PRODUCTOS  
COMBINADOS / COMBINED  
PRODUCTS

PUPITRE / DESK  
**ECLIPSE**

BANDEJA / TRAY  
**BOX**

SILLA / CHAIR  
**SOFT R**

GRADA / TIERED SEATS

**AGORA**  
**AGORA C**

PERCHA / COAT HOOKS  
**CADI**



# Colaborativo *Collaborative*

02. AMBIENTES / ENVIRONMENTS



PRODUCTOS  
COMBINADOS / COMBINED  
PRODUCTS

PUPITRE / DESK  
**PETAL**

BANDEJA / TRAY  
**BOX**

SILLA / CHAIR  
**SOFT**

ALMACENAJE / STORAGE  
**DOT 159 M**  
**DOT 159 C**  
**DOT 159 P**

PERCHA / COATHOOKS  
**CADI**

ACCESORIOS / ACCESSORIES  
**PIZARRA / WHITEBOARD**

PRODUCTOS  
COMBINADOS / COMBINED  
PRODUCTS

MESA / TABLE  
**KIDDY R**  
**KIDDY SC**

SILLA / CHAIR  
**PIVOT**  
**KIDDY VINTA**

ALMACENAJE / STORAGE  
**DOT 82 C**  
**DOT 82 A**

PERCHA / COATHOOKS  
**CADI PLUS**

## Infantil *Infants*





## Infantil *Infants*

PRODUCTOS  
COMBINADOS / COMBINED  
PRODUCTS

MESA / TABLE  
**TWIST OVAL**  
DISC UP

SILLA / CHAIR  
**KIDDY COSY**

## Conventional *Conventional*

PRODUCTOS  
COMBINADOS / COMBINED  
PRODUCTS

PUPITRE / DESK  
DESK ONE

BANDEJA / TRAY  
BOX

MESA / TABLE  
PROF

SILLA / CHAIR  
SLIM  
SLIM PROF

ALMACENAJE / STORAGE  
DOT 197 T

ACCESORIOS / ACCESSORIES  
PIZARRA / WHITEBOARD



## Biblioteca *Library*

PRODUCTOS  
COMBINADOS / COMBINED  
PRODUCTS

MESA / TABLE  
**LINE**

SILLA / CHAIR  
**WOODY**

ALMACENAJE / STORAGE  
**DOT197T**  
**DOT197E**  
**DOT197R**

## Comedor *Dining hall*



PRODUCTOS  
COMBINADOS / COMBINED  
PRODUCTS

MESA / TABLE  
**KIDDY M**  
**TWIST R**  
**LINE**

SILLA / CHAIR  
**KIDDY COSY**  
**COSY**  
**SLIM**

ALMACENAJE / STORAGE  
**DOT 197 M**  
**DOT 82 P**



# Productos *Products*



Pupitres — *Desks*



# Desk One



ES

El pupitre Desk One, líneas puras. Siguiendo los valores de concepción y fabricación que Grau impregna en todas sus creaciones. Minimalista, simétrico, sin aristas vivas y diseñado para un uso prolongado. Versátil para la educación colaborativa o tradicional. Se entrega totalmente montado.

EN

The Desk One desk, pure lines. Following the values of concept and manufacture that Grau embodies in all its creations. Minimalist, symmetrical, with no sharp edges and designed for long use. Versatile for collaborative or traditional learning. Supplied fully assembled.



## ACCESORIOS / ACCESSORIES



Bandeja inyectada con polipropileno reforzado /  
Tray injection-moulded in reinforced polypropylene

## ACABADOS / FINISHES

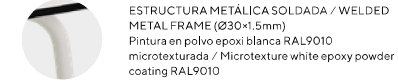
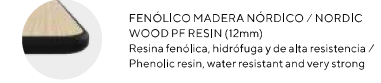
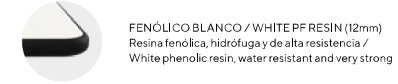

## \*MEDIDAS / MEASUREMENTS

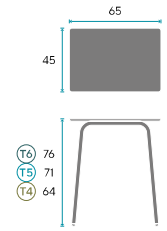

\*Todas las medidas son en centímetros / All measurements are in centimetres

## Desk Two

Pupitre doble para optimizar el espacio en áreas reducidas. / Double desk to optimise the use of space in small areas.

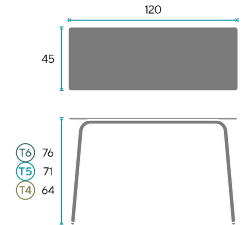

## COLABORATIVO / COLLABORATIVE

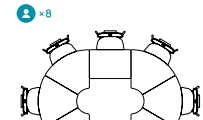
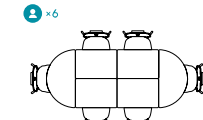
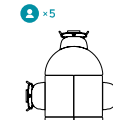
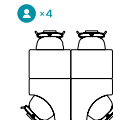
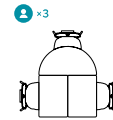

COMBINABLE  
CON /  
COMBINABLE  
WITH

END  
SHARP  
PETAL  
PAR

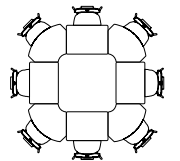
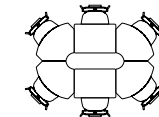

# Eclipse



ES

El pupitre Eclipse, fusión. Siguiendo los valores de concepción y fabricación que Grau impregna en todas sus creaciones. Minimalista, apilable, formas orgánicas y diseñado para un uso prolongado. Idóneo para la educación colaborativa. Se entrega totalmente montado.

APILABLE  
STACKABLE



EN

The Eclipse desk, fusion. Following the values of concept and manufacture that Grau embodies in all its creations. Minimalist, stackable, organic forms and designed for long use. Ideal for collaborative learning. Delivered fully assembled.

## ACCESORIOS / ACCESSORIES

GRAFITO  
GRAPHITE



TURQUESA  
TURQUOISE



OLIVA  
OLIVE



MOSTAZA  
MUSTARD



Bandeja inyectada con polipropileno reforzado /  
Tray injection-moulded in reinforced polypropylene

## ACABADOS / FINISHES



CDF BLANCO / WHITE CDF (16.4mm)  
Fibras de densidad compacta / Compact density fibres



FENÓLICO BLANCO / WHITE PF RESIN (12mm)  
Resina fenólica, hidrófuga y de alta resistencia /  
White phenolic resin, water resistant and very strong



FENÓLICO MADERA NÓRDICO / NORDIC  
WOOD PF RESIN (12mm)  
Resina fenólica, hidrófuga y de alta resistencia /  
Phenolic resin, water resistant and very strong



ESTRUCTURA METÁLICA SOLDADA / WELDED  
METAL FRAME (Ø30x1.5mm)  
Pintura en polvo epoxi blanca RAL9010  
microtexturada / Microtexture white epoxy powder  
coating RAL9010

## \*MEDIDAS / MEASUREMENTS

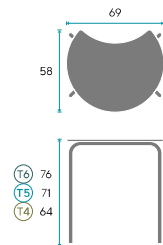

\* Todas las medidas son en centímetros / All measurements are in centimetres

## COLABORATIVO / COLLABORATIVE

2 x2



2 x3



2 x4

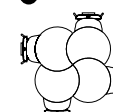

2 x5



# Petal



## ACCESORIOS / ACCESSORIES



Bandeja inyectada con polipropileno reforzado /  
Tray injection-moulded in reinforced polypropylene

## ACABADOS / FINISHES



CDF BLANCO / WHITE CDF (16.4mm)  
Fibras de densidad compacta / Compact density fibres

FENÓLICO BLANCO / WHITE PF RESIN (12mm)  
Resina fenólica, hidrófuga y de alta resistencia /  
White phenolic resin, water resistant and very strong

FENÓLICO MADERA NÓRDICO / NORDIC  
WOOD PF RESIN (12mm)  
Resina fenólica, hidrófuga y de alta resistencia /  
Phenolic resin, water resistant and very strong

ESTRUCTURA METÁLICA SOLDADA / WELDED  
METAL FRAME (Ø30x1.5mm)  
Pintura en polvo epoxi blanca RAL9010  
microtexturada / Microtexture white epoxy powder  
coating RAL9010

## \*MEDIDAS / MEASUREMENTS

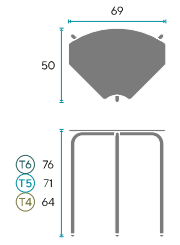

\*Todas las medidas son en centímetros / All  
measurements are in centimetres

ES

El pupitre Petal, armonía con la naturaleza. Siguiendo los valores de concepción y fabricación que Grau impregna en todas sus creaciones. Minimalista, formas orgánicas y diseñado para un uso prolongado. Idóneo para la educación colaborativa. Se entrega totalmente montado.

EN

The Petal desk, harmony with nature. Following the values of concept and manufacture that Grau embodies in all its creations. Minimalist, organic forms and designed for long use. Ideal for collaborative learning. Delivered fully assembled.

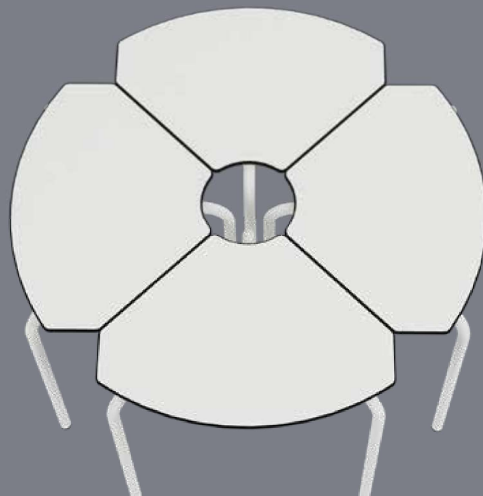

## COLABORATIVO / COLLABORATIVE

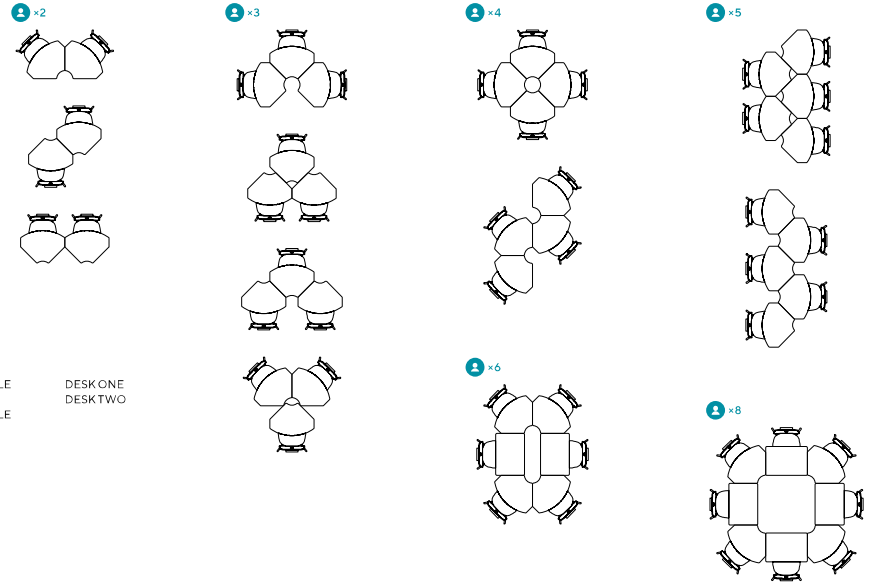

COMBINABLE  
CON /  
COMBINABLE  
WITH

DESK ONE  
DESK TWO

# End

ES

El pupitre End, acabado perfecto. Siguiendo los valores de concepción y fabricación que Grau impregna en todas sus creaciones. Minimalista, sin aristas vivas y diseñado para un uso prolongado. Idóneo para la educación colaborativa. Se entrega totalmente montado.

EN

The End desk, a perfect finish. Following the concept and manufacture that Grau embodies in all its creations. Minimalist, with no sharp edges and designed for long use. Ideal for collaborative learning. Supplied fully assembled.



## ACCESORIOS / ACCESSORIES



Bandeja inyectada con polipropileno reforzado /  
Tray injection-moulded in reinforced polypropylene

## ACABADOS / FINISHES

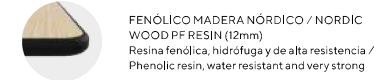
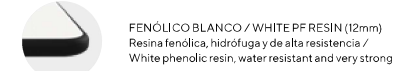

## \*MEDIDAS / MEASUREMENTS

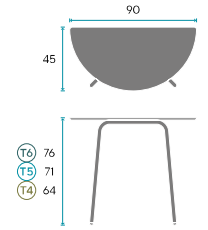

\*Todas las medidas son en centímetros / All  
measurements are in centimetres

## COLABORATIVO / COLLABORATIVE

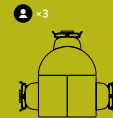
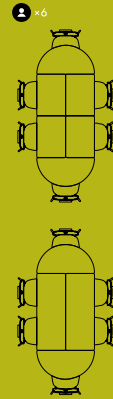
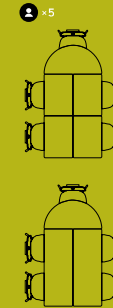
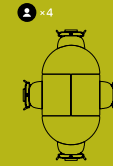

COMBINABLE  
CON /  
COMBINABLE  
WITH

DESK ONE  
DESK TWO



# Par



**ES**

El pupitre Par, conectividad. Siguiendo los valores de concepción y fabricación que Grau impregna en todas sus creaciones. Minimalista, sin aristas vivas y diseñado para un uso prolongado. Idóneo para la educación colaborativa. Se entrega totalmente montado.

**EN**

The Par desk, connectivity. Following the values of concept and manufacture that Grau embodies in all its creations. Minimalist, with no sharp edges and designed for long use. Ideal for collaborative learning. Supplied fully assembled.

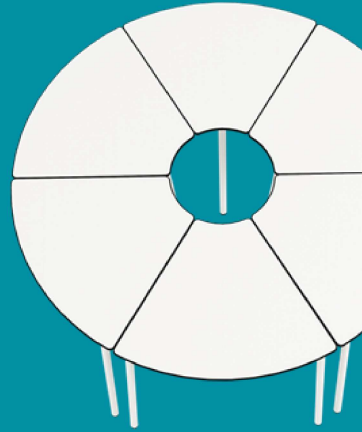

**ACCESORIOS / ACCESSORIES**



Bandeja inyectada con polipropileno reforzado / Tray injection-moulded in reinforced polypropylene

**ACABADOS / FINISHES**



CDF BLANCO / WHITE CDF (16.4mm)  
Fibras de densidad compacta / Compact density fibres

FENÓLICO BLANCO / WHITE PF RESIN (12mm)  
Resina fenólica, hidrófuga y de alta resistencia / White phenolic resin, water resistant and very strong

FENÓLICO MADERA NÓRDICO / NORDIC WOOD PF RESIN (12mm)  
Resina fenólica, hidrófuga y de alta resistencia / Phenolic resin, water resistant and very strong

ESTRUCTURA METÁLICA SOLDADA / WELDED METAL FRAME (Ø30x1.5mm)  
Pintura en polvo epoxi blanca RAL9010 microtexturada / Microtexture white epoxy powder coating RAL9010

**\*MEDIDAS / MEASUREMENTS**

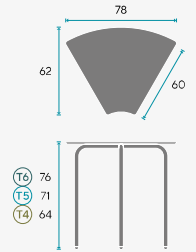

\*Todas las medidas son en centímetros / All measurements are in centimetres

**COLABORATIVO / COLLABORATIVE**

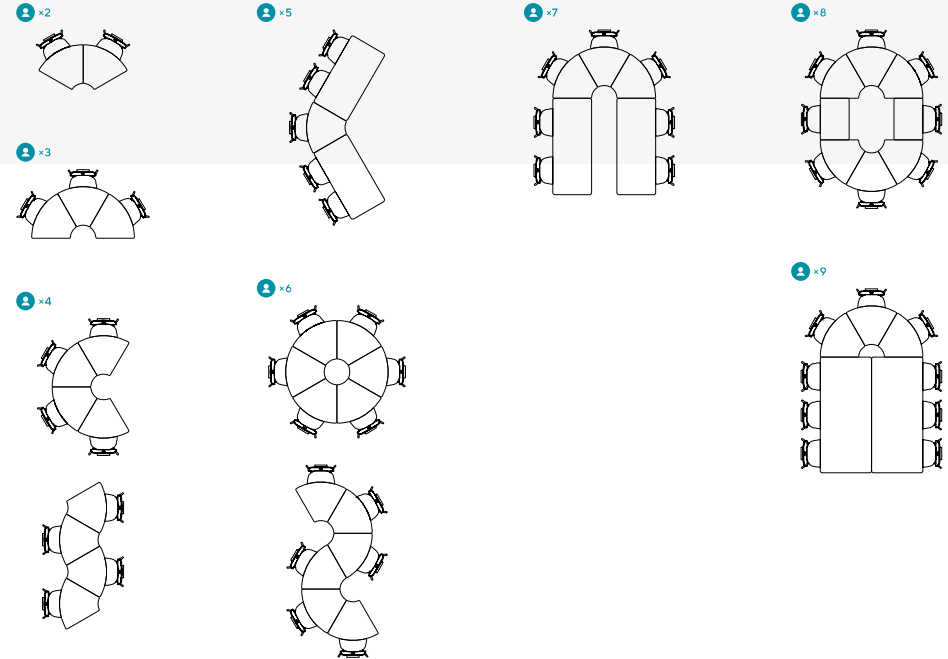

COMBINABLE CON / COMBINABLE WITH  
DESK ONE  
DESK TWO

# Sharp



ES

El pupitre Sharp define la dirección. Siguiendo los valores de concepción y fabricación que Grau impregna en todas sus creaciones. Posición izquierda, derecha o frontal. Minimalista, sin aristas vivas y diseñado para un uso prolongado. Idóneo para la educación colaborativa. Se entrega totalmente montado.

EN

The Sharp desk, defines direction. Following the values of concept and manufacture that Grau embodies in all its creations. Can be joined left and right or front and designed for long use. Ideal for collaborative learning. Supplied fully assembled.

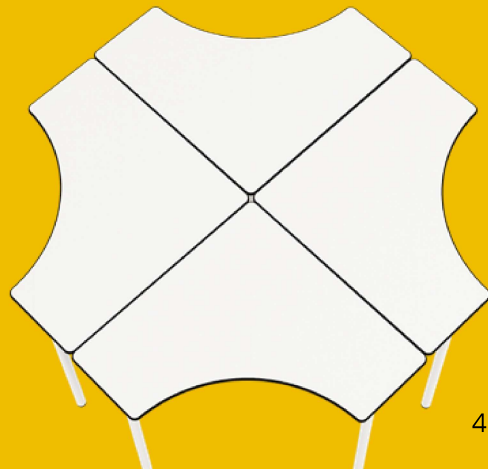

## ACCESORIOS / ACCESSORIES



Bandeja inyectada con polipropileno reforzado / Tray injection-moulded in reinforced polypropylene

## ACABADOS / FINISHES



CDF BLANCO / WHITE CDF (16.4mm)  
Fibras de densidad compacta / Compact density fibres

FENÓLICO BLANCO / WHITE PF RESIN (12mm)  
Resina fenólica, hidrófuga y de alta resistencia / White phenolic resin, water resistant and very strong

FENÓLICO MADERA NÓRDICO / NORDIC WOOD PF RESIN (12mm)  
Resina fenólica, hidrófuga y de alta resistencia / Phenolic resin, water resistant and very strong

ESTRUCTURA METÁLICA SOLDADA / WELDED METAL FRAME (Ø30x1.5mm)  
Pintura en polvo epoxi blanca RAL9010 microtexturada / Microtexture white epoxy powder coating RAL9010

## \*MEDIDAS / MEASUREMENTS

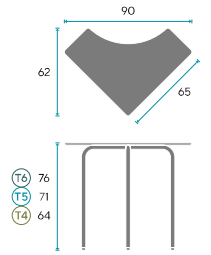

\*Todas las medidas son en centímetros / All measurements are in centimetres

## COLABORATIVO / COLLABORATIVE

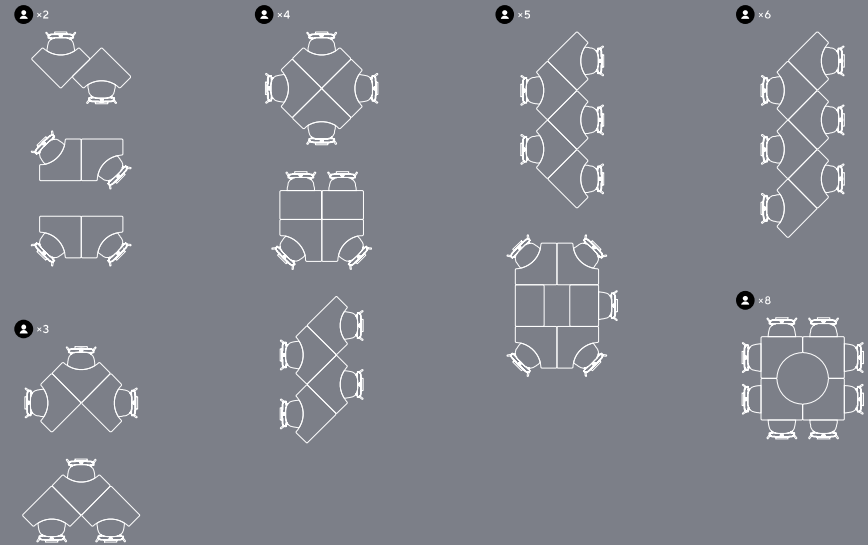

COMBINABLE CON / COMBINABLE WITH

DESK ONE / DESK TWO

# Pile



ES

EN

El pupitre Pile, verticalidad. Siguiendo los valores de concepción y fabricación que Grau impregna en todas sus creaciones. Minimalista, apilable frontalmente, sin aristas vivas y diseñado para un uso prolongado. Versátil para la educación colaborativa o tradicional. Se entrega totalmente montado.

The Pile desk, verticality. Following the values of concept and manufacture that Grau embodies in all its creations. Minimalist, frontally stackable longways, with no sharp edges and designed for long use. Versatile for collaborative and traditional learning. Supplied fully assembled.

APILABLE  
STACKABLE



## ACCESORIOS / ACCESSORIES



Bandeja inyectada con polipropileno reforzado /  
Tray injection-moulded in reinforced polypropylene

## ACABADOS / FINISHES



CDF BLANCO / WHITE CDF (16.4mm)  
Fibras de densidad compacta / Compact density fibres

FENÓLICO BLANCO / WHITE PF RESIN (12mm)  
Resina fenólica, hidrófuga y de alta resistencia /  
White phenolic resin, water resistant and very strong

FENÓLICO MADERA NÓRDICO / NORDIC  
WOOD PF RESIN (12mm)  
Resina fenólica, hidrófuga y de alta resistencia /  
Phenolic resin, water resistant and very strong

ESTRUCTURA METÁLICA SOLDADA / WELDED  
METAL FRAME (Ø30x1.5mm)  
Pintura en polvo epoxi blanca RAL9010  
microtexturada / Microtexture white epoxy powder  
coating RAL9010

## \*MEDIDAS / MEASUREMENTS

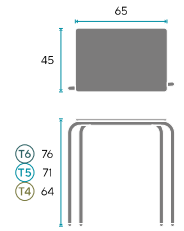

\*Todas las medidas son en centímetros / All  
measurements are in centimetres

## COLABORATIVO / COLLABORATIVE

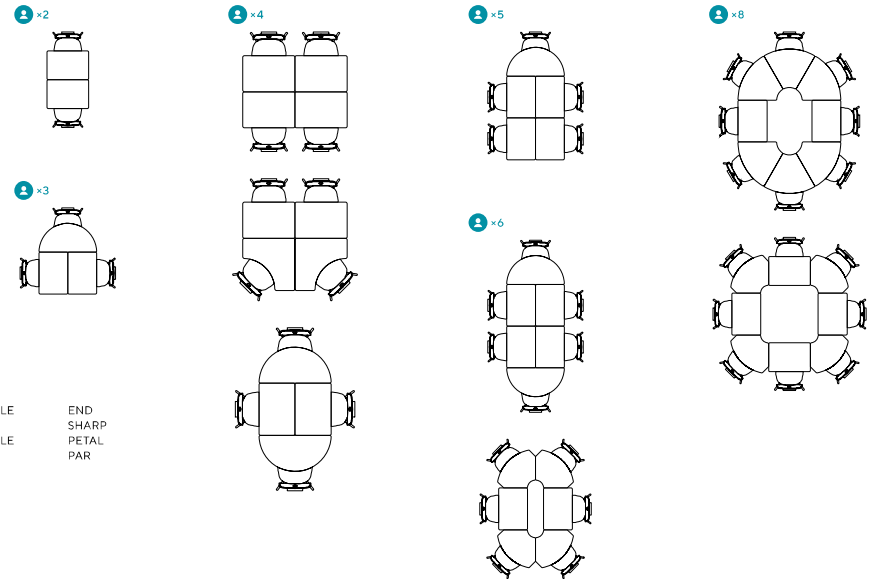

COMBINABLE  
CON /  
COMBINABLE  
WITH

END  
SHARP  
PETAL  
PAR



PUPITRE / DESK

# Box

BANDEJA / TRAY

COLORES / COLOURS

CARACTERÍSTICAS / FEATURES

\* MEDIDAS / MEASUREMENTS

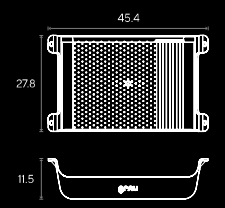
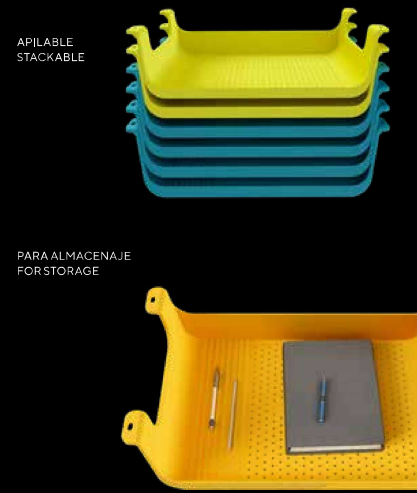

Bandeja inyectada con polipropileno reforzado / Tray injection-moulded in reinforced polypropylene

\* Todas las medidas son en centímetros / All measurements are in centimetres

APLICACIÓN / APPLICATION

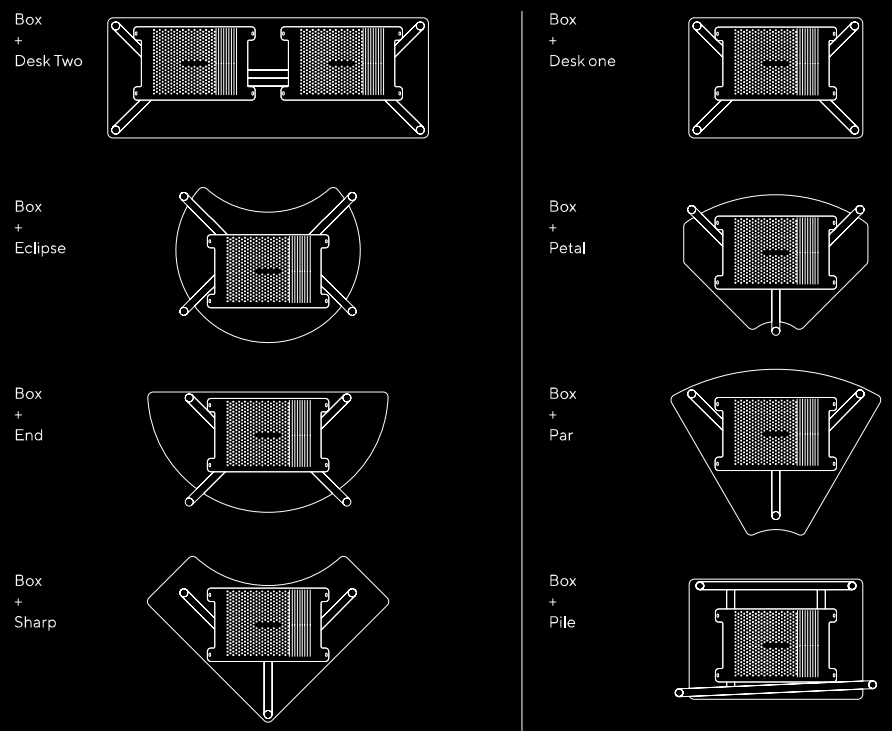

ES

EN

La bandeja Box, cada cosa en su sitio. Siguiendo los valores de concepción y fabricación que Grau impregna en todas sus creaciones. Colores armónicos. Sin aristas vivas y diseñada para un uso prolongado. Versátil para la educación colaborativa o tradicional. Se entrega totalmente montada.

The Box tray, everything in its place. Following the values of concept and manufacture that Grau embodies in all its creations. Harmonious colours. No sharp edges and designed for long use. Versatile for collaborative and traditional learning. Supplied fully assembled.

# Productos *Products*



Mesas — *Tables*



# Twist Oval

ES

La mesa Twist, polivalencia absoluta. Siguiendo los valores de concepción y fabricación que Grau impregna en todas sus creaciones. Minimalista, con ruedas, plegable, con opción rotulable. Sin aristas vivas y diseñada para un uso prolongado. Versátil para la educación colaborativa y comedores. Se entrega totalmente montada.

EN

The Twist table, total versatility. Following the values of concept and manufacture that Grau embodies in all its creations. Minimalist, with casters, foldable and usable as a whiteboard (optional). No sharp edges and designed for long use. Versatile for collaborative learning and dining halls. Supplied fully assembled.



PLEGABLE  
FOLDABLE



ROTULABLE  
WHITEBOARD

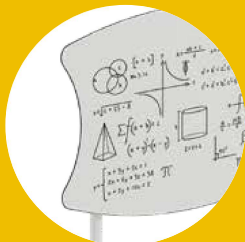

CONFRENOS  
WITH BRAKES



## ACABADOS / FINISHES



CDF BLANCO / WHITE CDF (16.4mm)  
Fibras de densidad compacta / Compact density fibres



FENÓLICO BLANCO / WHITE PF RESIN (12mm)  
Resina fenólica, hidrófuga y de alta resistencia / White phenolic resin, water resistant and very strong



FENÓLICO MADERA NÓRDICO / NORDIC WOOD PF RESIN (12mm)  
Resina fenólica, hidrófuga y de alta resistencia / Phenolic resin, water resistant and very strong



MELAMINA ROTULABLE / MARKABLE MELAMINE (19mm)  
Canteado PVC / PVC edges



ESTRUCTURA METÁLICA SOLDADA / WELDED METAL FRAME  
Pintura en polvo epoxi blanca RAL9010 microtexturada / Microtexture white epoxy powder coating RAL9010

## \* MEDIDAS / MEASUREMENTS

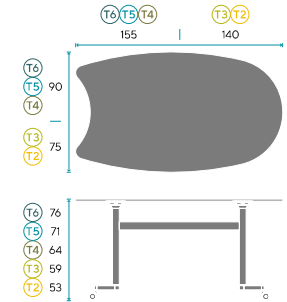

\* Todas las medidas son en centímetros / All measurements are in centimetres

## Twist R

### VERSIONES / VERSIONS



PLEGABLE  
FOLDABLE

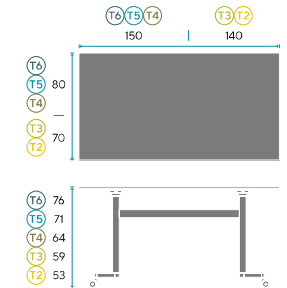
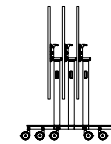

### COLABORATIVO / COLLABORATIVE

1 x8

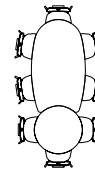

2 x12

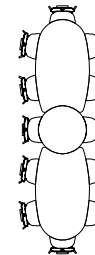

3 x14

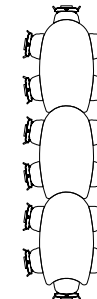

4 x15

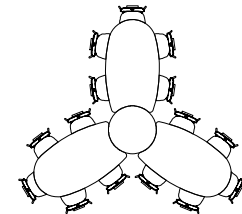

5 x17

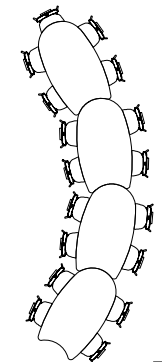

COMBINABLE  
CON /  
COMBINABLE  
WITH

DISC UP

# Disc Up

ES

La mesa Disc Up, no importa la altura. Siguiendo los valores de concepción y fabricación que Grau impregna en todas sus creaciones. Circular y minimalista, altura regulable y diseñada para un uso prolongado. Idónea para la educación colaborativa. Se entrega totalmente montada.

EN

The Disc Up table, height is no object. Following the values of concept and manufacture that Grau embodies in all its creations. Round and minimalist, adjustable height and designed for long use. Ideal for collaborative learning. Supplied fully assembled.



## ACABADOS / FINISHES



CDF BLANCO / WHITE CDF (16.4mm)  
Fibras de densidad compacta / Compact density fibres



FENÓLICO BLANCO / WHITE PF RESIN (12mm)  
Resina fenólica, hidrófuga y de alta resistencia / White phenolic resin, water resistant and very strong



FENÓLICO MADERA NÓRDICO / NORDIC WOOD PF RESIN (12mm)  
Resina fenólica, hidrófuga y de alta resistencia / Phenolic resin, water resistant and very strong



ESTRUCTURA METÁLICA SOLDADA / WELDED METAL FRAME  
Pintura en polvo epoxi blanca RAL9010 microtexturada / Microtexture white epoxy powder coating RAL9010

## \* MEDIDAS / MEASUREMENTS

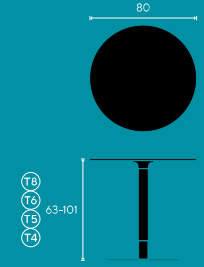

\* Todas las medidas son en centímetros / All measurements are in centimetres

## CARACTERÍSTICAS / FEATURES

ALTURA  
REGULABLE  
ADJUSTABLE  
HEIGHT



## COLABORATIVO / COLLABORATIVE

8



12



15

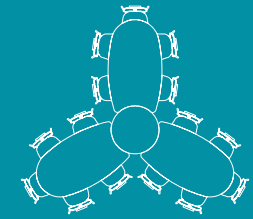

COMBINABLE  
CON/  
COMBINABLE  
WITH

TWIST OVAL

# Line



ES

La mesa Line, líneas sin fin. Siguiendo los valores de concepción y fabricación que Grau impregna en todas sus creaciones. Minimalista y robusta. Sin aristas vivas y diseñada para un uso prolongado. Versátil para la educación colaborativa o tradicional y para comedores. Se entrega totalmente montada.

EN

The Line table, unending lines. Following the values of concept and manufacture that Grau embodies in all its creations. Minimalist and robust. No sharp edges and designed for long use. Versatile for collaborative or traditional learning and dining halls. Supplied fully assembled.



NIVELADORES  
ADJUSTABLE FEET



## ACABADOS / FINISHES

- 

CDF BLANCO / WHITE CDF (16.4mm)  
Fibras de densidad compacta / Compact density fibres
- 

FENÓLICO BLANCO / WHITE PF RESIN (12mm)  
Resina fenólica, hidrófuga y de alta resistencia / White phenolic resin, water resistant and very strong
- 

FENÓLICO MADERA NÓRDICO / NORDIC WOOD PF RESIN (12mm)  
Resina fenólica, hidrófuga y de alta resistencia / Phenolic resin, water resistant and very strong
- 

ESTRUCTURA METÁLICA SOLDADA / WELDED METAL FRAME (PATAS / LEGS Ø40x1.5mm)  
Pintura en polvo epoxi blanca RAL9010 microtexturada / Microtexture white epoxy powder coating RAL9010

## ACCESORIOS / ACCESSORIES

FALDÓN FRONTAL  
FRONT PANEL

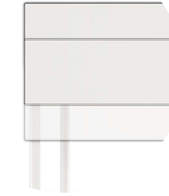

PASACABLES  
CABLE ENTRY



CANAL  
CABLE TRAY



CPU  
CPU



## \*MEDIDAS / MEASUREMENTS

Line 200

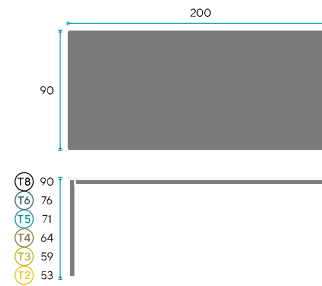

Line 180

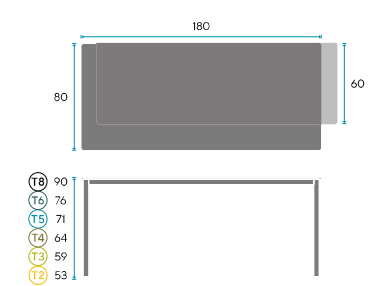

Line 150

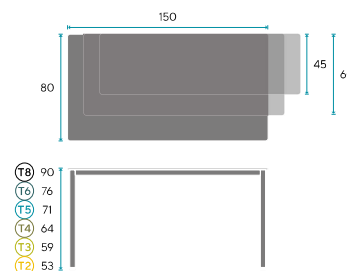

Line 120

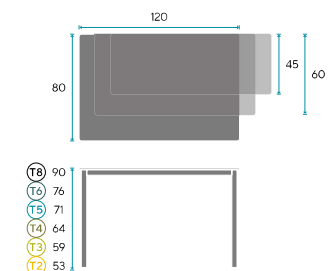

# Disc F



ES

La mesa Disc F, punto de encuentro. Siguiendo los valores de concepción y fabricación que Grau impregna en todas sus creaciones. Circular y minimalista. Diseñada para un uso prolongado. Idónea para la educación colaborativa. Se entrega totalmente montada.

EN

The Disk F table, meeting point. Following the values of concept and manufacture that Grau embodies in all its creations. Round and minimalist. Designed for long use. Ideal for collaborative learning. Supplied fully assembled.



## \* MEDIDAS / MEASUREMENTS

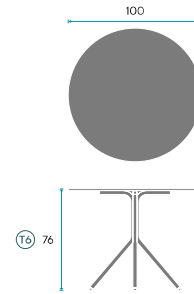

\* Todas las medidas son en centímetros / All measurements are in centimetres

## ACABADOS / FINISHES



CDF BLANCO / WHITE CDF (16.4mm)  
Fibras de densidad compacta / Compact density fibres

FENÓLICO BLANCO / WHITE PF RESIN (12mm)  
Resina fenólica, hidrófuga y de alta resistencia / White phenolic resin, water resistant and very strong

FENÓLICO MADERA NÓRDICO / NORDIC WOOD PF RESIN (12mm)  
Resina fenólica, hidrófuga y de alta resistencia / Phenolic resin, water resistant and very strong



ESTRUCTURA METÁLICA SOLDADA / WELDED METAL FRAME (Ø30x1.5mm)  
Pintura en polvo epoxi blanca RAL9010 microtexturada / Microtexture white epoxy powder coating RAL9010

# Prof



ES

La mesa Prof, donde todo empieza. Siguiendo los valores de concepción y fabricación que Grau impregna en todas sus creaciones. Minimalista y robusta. Sin aristas vivas y diseñada para un uso prolongado. Idónea para la educación colaborativa o tradicional. Se entrega totalmente montada.

EN

The Prof table, where everything begins. Following the values of concept and manufacture that Grau embodies in all its creations. Minimalist and robust. No sharp edges and designed for long use. Ideal for collaborative and traditional learning. Supplied fully assembled.



## \* MEDIDAS / MEASUREMENTS

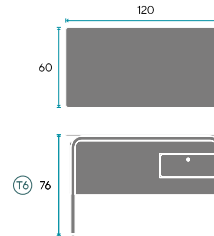

## ACABADOS / FINISHES



CDF BLANCO / WHITE CDF (16.4mm)  
Fibras de densidad compacta / Compact density fibres

FENÓLICO BLANCO / WHITE PF RESIN (12mm)  
Resina fenólica, hidrófuga y de alta resistencia / White phenolic resin, water resistant and very strong

FENÓLICO MADERA NÓRDICO / NORDIC WOOD PF RESIN (12mm)  
Resina fenólica, hidrófuga y de alta resistencia / Phenolic resin, water resistant and very strong

ESTRUCTURA METÁLICA SOLDADA / WELDED METAL STRUCTURE (Ø30x1.5mm)  
Pintura en polvo epoxi blanca RAL9010 microtexturada / Microtexture white epoxy powder coating RAL9010

## ACCESORIOS / ACCESSORIES

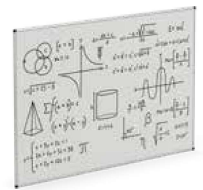

PIZARRA WHITEBOARD

# Duo



ES

La mesa Duo, ¡hora de comer! Siguiendo los valores de concepción y fabricación que Grau impregna en todas sus creaciones. Minimalista, robusta y con bancos plegables para facilitar la limpieza. Sin aristas vivas y diseñada para un uso prolongado. Idónea para comedores tradicionales. Se entrega totalmente montada.

EN

The Duo table, time for lunch! Following the values of concept and manufacture that Grau embodies in all its creations. Minimalist, robust and with foldable benches for cleaning. No sharp edges and designed for long use. Ideal for traditional dining halls. Supplied fully assembled.



## \* MEDIDAS / MEASUREMENTS

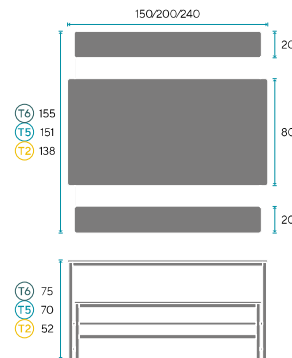

## ACABADOS / FINISHES



CDF BLANCO / WHITE CDF (16.4mm)  
Fibras de densidad compacta / Compact density fibres

ESTRUCTURA METÁLICA SOLDADA / WELDED METAL FRAME (30x30x1.5mm)  
Pintura en polvo epoxi blanca RAL9010 microtexturada / Microtexture white epoxy powder coating RAL9010

## CARACTERÍSTICAS / FEATURES

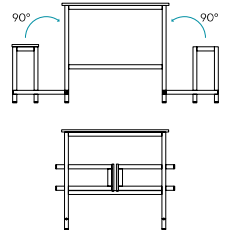

PLEGABLE FOLDABLE

# Productos *Products*



Sillas — *Chairs*



## Soft



ES

La silla Soft, dinamismo constante. Siguiendo los valores de concepción y fabricación que Grau impregna en todas sus creaciones. Ligera y dinámica. Colores armónicos. Sin aristas vivas y diseñada para un uso prolongado. Versátil para la educación colaborativa o tradicional. Se entrega totalmente montada.

EN

The Soft chair, constant dynamism. Following the values of concept and manufacture that Grau embodies in all its creations. Light and dynamic. Harmonious colours. No sharp edges and designed for long use. Versatile for collaborative or traditional learning. Supplied fully assembled.

GANCHO  
HOOKAPILABLE  
STACKABLE

ESTRUCTURA METÁLICA SOLDADA / WELDED  
METAL FRAME (Ø20x1,5mm)  
Pintura en polvo epoxi blanca RAL9010 microtexturada /  
Microtexture white epoxy powder coating RAL9010

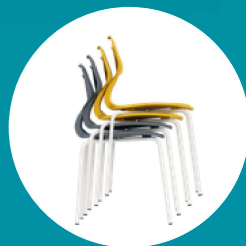

## COLORES / COLOURS

GRAFITO  
GRAPHITETURQUESA  
TURQUOISEOLIVA  
OLIVEMOSTAZA  
MUSTARD

## \*MEDIDAS / MEASUREMENTS

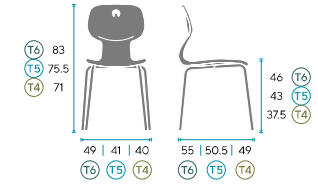

## VERSIONES / VERSIONS

## Soft R

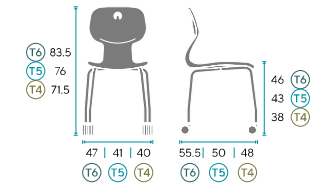
CON RUEDAS  
WITH CASTERS

## Soft F

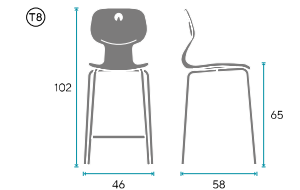

\* Todas las medidas son en centímetros / All  
measurements are in centimetres



## Slim

APILABLE  
STACKABLE

ESTRUCTURA METÁLICA SOLDADA /  
WELDED METAL FRAME (Ø22x1.5mm)  
Pintura en polvo epoxi blanco RAL9010  
microtexturado / Microtexture white epoxy  
powder coating RAL9010



ES

La silla Slim, una para todo. Siguiendo los valores de concepción y fabricación que Grau impregna en todas sus creaciones. Amplia gama, minimalista y ligera. Colores armónicos. Sin aristas vivas y diseñada para un uso prolongado. Versátil para la educación colaborativa o tradicional. Se entrega totalmente montada.

EN

The Slim chair, one for everyone. Following the values of concept and manufacture that Grau embodies in all its creations. Big range, minimalist and light. Harmonious colours. No sharp edges and designed for long use. Versatile for collaborative or traditional learning. Supplied fully assembled.

## COLORES / COLOURS

GRAFITO  
GRAPHITETURQUESA  
TURQUOISEOLIVA  
OLIVEMOSTAZA  
MUSTARD

## \*MEDIDAS / MEASUREMENTS

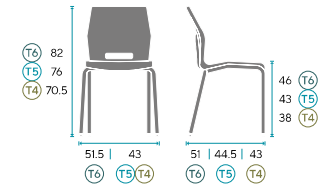

## VERSIONES / VERSIONS

## Slim R

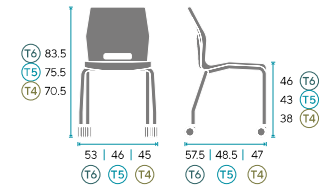
CON RUEDAS  
WITH CASTERS

## Slim Up

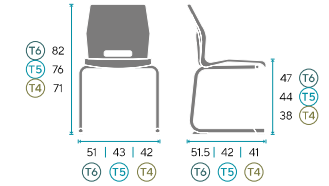

## Slim P

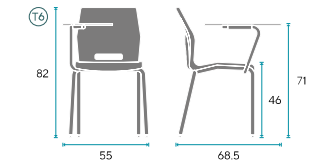

\*Todas las medidas son en centímetros / All  
measurements are in centimetres

## Slim F



ES

El taburete Slim, el más alto. Siguiendo los valores de concepción y fabricación que Grau impregna en todas sus creaciones. Taburete alto, minimalista y ligero. Colores armónicos. Sin aristas vivas y diseñado para un uso prolongado. Versátil para la educación colaborativa o tradicional. Se entrega totalmente montado.

ESTRUCTURA METÁLICA SOLDADA / WELDED METAL FRAME (Ø22x1.5mm)  
Pintura en polvo epoxi blanco RAL9010 microtexturado / Microtexture white epoxy powder coating RAL9010

EN

The Slim high stool, at the top. Following the values of concept and manufacture that Grau embodies in all its creations. High stool, minimalist and light. Harmonious colours. No sharp edges and designed for long use. Versatile for collaborative or traditional learning. Supplied fully assembled.

## COLORES / COLOURS

GRAFITO  
GRAPHITETURQUESA  
TURQUOISEOLIVA  
OLIVEMOSTAZA  
MUSTARD

## \*MEDIDAS / MEASUREMENTS

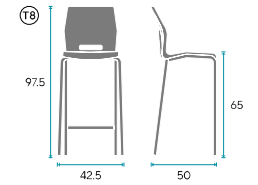

## Slim G

## VERSIONES / VERSIONS

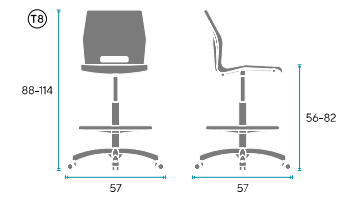

## Slim Prof

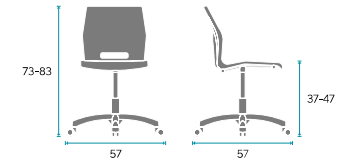

## Slim B

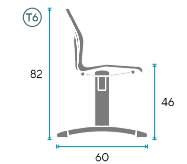
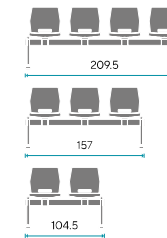
PIES CROMADOS  
CHROME PLATED FEET

\* Todas las medidas son en centímetros / All measurements are in centimetres

## Vinta

APILABLE  
STACKABLEGANCHO  
HOOK

ES

La silla Vinta, la clásica. Siguiendo los valores de concepción y fabricación que Grau impregna en todas sus creaciones. Robusta y apilable. Sin aristas vivas y diseñada para un uso prolongado. Versátil para la educación colaborativa o tradicional. Se entrega totalmente montada.

EN

The Vinta chair, a classic. Following the values of concept and manufacture that Grau embodies in all its creations. Sturdy and stackable. No sharp edges and designed for long use. Versatile for collaborative or traditional learning. Supplied fully assembled.

ESTRUCTURA METÁLICA SOLDADA / WELDED METAL FRAME (Ø20x1.5mm)  
Pintura en polvo epoxi blanco RAL9010 microtexturado / Microtexture white epoxy powder coating RAL9010

## COLORES / COLOURS

TURQUESA  
TURQUOISEMOSTAZA  
MUSTARDMADERA NÓRDICA  
NORDIC WOOD

## \* MEDIDAS / MEASUREMENTS

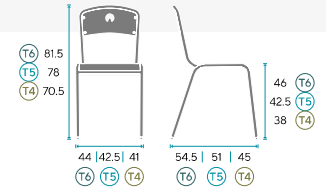

## VERSIONES / VERSIONS

## Kiddy Vinta

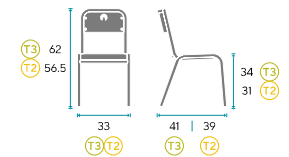

\* Todas las medidas son en centímetros / All measurements are in centimetres

## Cosy

APILABLE  
STACKABLE

ES

La silla Cosy, práctica. Siguiendo la línea de colores que Grau impregna en todas sus creaciones. Monobloque, ligera y apilable. Uso para interior o exterior. Versátil para comedores y para la educación colaborativa o tradicional.

EN

The Cosy chair, practical. Following the colours range that Grau embodies in all its creations. Single-piece, light and stackable. For indoor or outdoor use. Versatile for dining halls and collaborative or traditional learning.

## COLORES / COLOURS

TURQUESA  
TURQUOISEMOSTAZA  
MUSTARD

## \*MEDIDAS / MEASUREMENTS

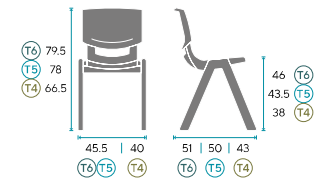

## VERSIONES / VERSIONS

## Kiddy Cosy

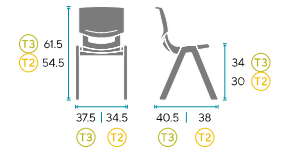
APILABLE  
STACKABLE

\* Todas las medidas son en centímetros / All measurements are in centimetres

## Woody



ES

La silla Woody, elegancia atemporal. Siguiendo los valores de concepción y fabricación que Grau impregna en todas sus creaciones. Robusta y apilable. Sin aristas vivas y diseñada para un uso prolongado. Versátil para bibliotecas y para la educación colaborativa o tradicional. Se entrega totalmente montada.

EN

The Woody chair, timeless elegance. Following the values of concept and manufacture that Grau embodies in all its creations. Sturdy and stackable. No sharp edges and designed for long use. Versatile for libraries and collaborative or traditional learning. Supplied fully assembled.



ESTRUCTURA METÁLICA SOLDADA / WELDED METAL FRAME (Ø20x1.5mm)  
Pintura en polvo epoxi blanco RAL9010 microtexturado / Microtexture white epoxy powder coating RAL9010

APILABLE  
STACKABLEGANCHO  
HOOK

\* MEDIDAS / MEASUREMENTS

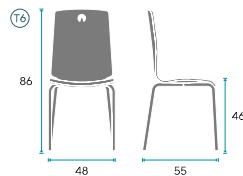

\* Todas las medidas son en centímetros / All measurements are in centimetres

## Pivot



ES

El taburete Pivot, ergonomía dinámica de 360°. Siguiendo los valores de concepción y fabricación que Grau impregna en todas sus creaciones. Robusto y pivotante, con asiento de madera maciza. Sin aristas vivas y diseñado para un uso prolongado. Idóneo para la educación colaborativa. Se entrega totalmente montado.

EN

The Pivot stool, 360° dynamic ergonomics. Following the values of concept and manufacture that Grau embodies in all its creations. Sturdy and tilting, with a seat made in solid wood. No sharp edges and designed for long use. Ideal for collaborative learning. Supplied fully assembled.



CARACTERÍSTICAS / FEATURES

PIVOTANTE  
TILTING

\* MEDIDAS / MEASUREMENTS

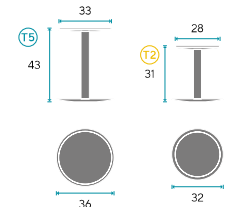

\* Todas las medidas son en centímetros / All measurements are in centimetres

# Productos *Products*



Almacenaje — *Storage*



# Dot 82



ES

Los armarios Dot 82, un toque de personalidad. Siguiendo los valores de concepción y fabricación que Grau impregna en todas sus creaciones. Minimalistas, robustos y con acabados neutros nórdicos, en que los colores los aporta el material escolar. Armarios bajos para almacenaje con estantes, cartulíneros o bandejas. Puertas de CDF sin aristas vivas. Diseñados para un uso prolongado. Versátiles para la educación colaborativa o tradicional. Se entregan totalmente montados.

EN

The Dot 82 cupboards, a touch of character. Following the values of concept and manufacture that Grau embodies in all its creations. Minimalist, sturdy and with neutral Scandinavian finishes with colour carried by the school stuff. Low cupboards for storage on shelves and wide card shelves or in trays. CDF doors without sharp edges. Designed for long use. Versatile for collaborative or traditional learning. Supplied fully assembled.

ACABADOS / FINISHES

GRAFITO  
GRAPHITE



OLIVA  
OLIVE



TURQUESA  
TURQUOISE



MOSTAZA  
MUSTARD



ACCESORIOS / ACCESSORIES

BANDEJAS  
TRAYS



CERRADURA  
LOCK



GRANDE / LARGE  
ÚTILES / EFFECTIVE 15 × 32 × 25,5  
PEQUEÑA / SMALL  
ÚTILES / EFFECTIVE 7 × 33 × 27



CARACTERÍSTICAS / FEATURES

NIVELADOR  
HEIGHT-  
ADJUSTABLE  
FOOT

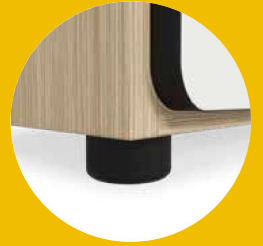

Dot 82 E



Dot 82 P



Dot 82 A



Dot 82 B



Dot 82 C



Dot 82 F



MEDIDAS / MEASUREMENTS \*

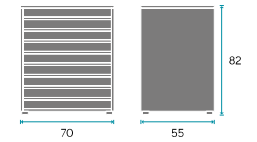
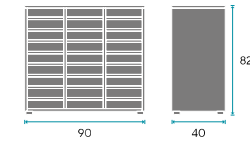
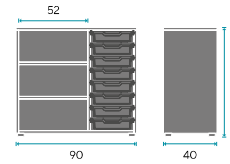
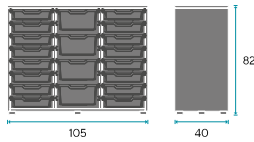
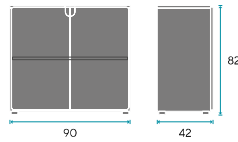
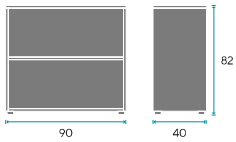

\* Todas las medidas son en centímetros / All measurements are in centimetres

# Dot 159



ES

Los armarios Dot 159, un toque de personalidad. Siguiendo los valores de concepción y fabricación que Grau impregna en todas sus creaciones. Minimalistas, robustos y con acabados neutros nórdicos, en que los colores los aporta el material escolar. Armarios medianos para almacenaje con estantes, casilleros o bandejas. Puertas de CDF altas y bajas sin aristas vivas. Diseñados para un uso prolongado. Versátiles para la educación colaborativa o tradicional. Se entregan totalmente montados.

EN

The Dot 159 cupboards, a touch of character. Following the values of concept and manufacture that Grau embodies in all its creations. Minimalist, sturdy and in neutral Nordic finishes where colour is carried by the school stuff. Medium sized cupboards for storage on shelves or in boxes and trays. Tall and low-height CDF doors without sharp edges. Designed for long use. Versatile for collaborative or traditional learning. Supplied fully assembled.

ACABADOS / FINISHES

GRAFITO  
GRAPHITE

TURQUESA  
TURQUOISE



OLIVA  
OLIVE

MOSTAZA  
MUSTARD



ACCESORIOS / ACCESSORIES

BANDEJAS  
TRAYS



GRANDE / LARGE  
UTILES / EFFECTIVE 15 x 32 x 25.5  
PEQUEÑA / SMALL  
UTILES / EFFECTIVE 7 x 33 x 27



CERRADURA  
LOCK



CARACTERÍSTICAS / FEATURES

NIVELADOR  
HEIGHT-  
ADJUSTABLE  
FOOT



Dot 159 E

Dot 159 M

Dot 159 P

Dot 159 A

Dot 159 C



MEDIDAS / MEASUREMENTS \*

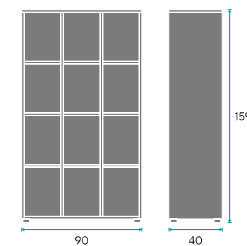
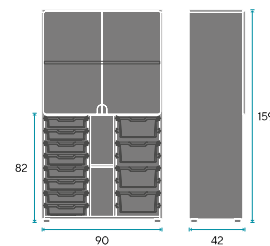
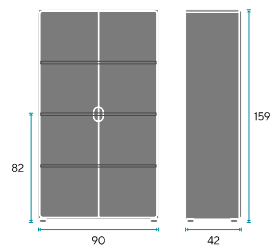
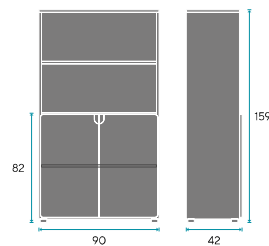
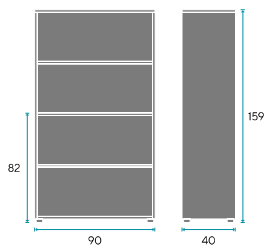

\* Todas las medidas son en centímetros / All measurements are in centimetres



# Dot 197



ES

Los armarios Dot 197, un toque de personalidad. Siguiendo los valores de concepción y fabricación que Grau impregna en todas sus creaciones. Minimalistas, robustos y con acabados neutros nórdicos, en que los colores los aporta el material escolar. Armarios altos para almacenaje con estantes, expositores, vitrinas o taquillas. Puertas de CDF altas y bajas sin aristas vivas. Diseñados para un uso prolongado. Versátiles para la educación colaborativa o tradicional. Se entregan totalmente montados.

EN

The Dot 159 cupboards, a touch of character. Following the values of concept and manufacture that Grau embodies in all its creations. Minimalist, sturdy and in neutral Nordic finishes where colour is carried by the school stuff. Tall cupboards for storage on shelves, with display cabinets, trays or lockers. Tall and low-height CDF doors without sharp edges. Designed for long use. Versatile for collaborative or traditional learning. Supplied fully assembled.

ACABADOS / FINISHES

GRAFITO  
GRAPHITE

TURQUESA  
TURQUOISE



OLIVA  
OLIVE

MOSTAZA  
MUSTARD



ACCESORIOS / ACCESSORIES

BANDEJAS  
TRAYS



GRANDE / LARGE  
ÚTILES / EFFECTIVE 15 x 32 x 25.5  
PEQUEÑA / SMALL  
ÚTILES / EFFECTIVE 7 x 33 x 27



CERRADURA  
LOCK



CARACTERÍSTICAS / FEATURES

NIVELADOR  
HEIGHT-  
ADJUSTABLE  
FOOT



Dot 197 E



Dot 197 M



Dot 197 V



Dot 197 P



Dot 197 R



Dot 197 T



CERRADURA  
LOCK



MEDIDAS / MEASUREMENTS \*

\* Todas las medidas son en centímetros / All measurements are in centimetres

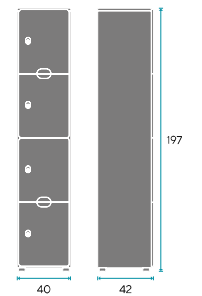
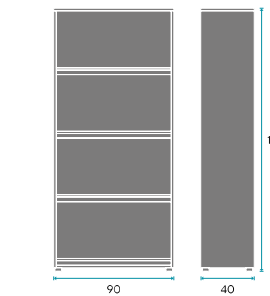
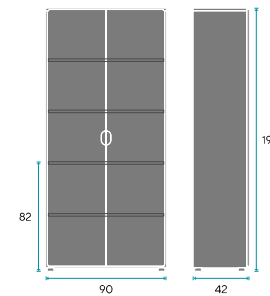
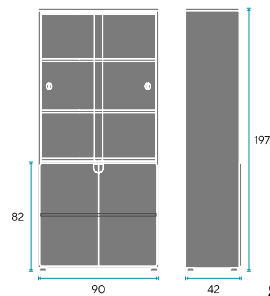
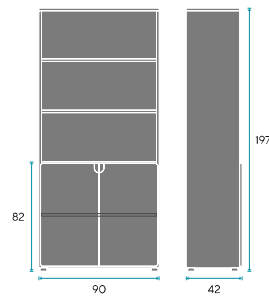
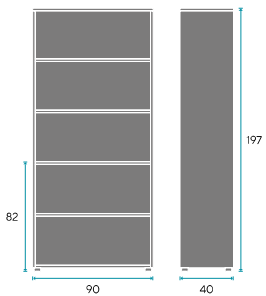

# Agora



ES

La grada Agora, ¿debatimos? Siguiendo los valores de concepción y fabricación que Grau impregna en todas sus creaciones. Minimalista y robusta. Superficie de fenólico y puertas de CDF sin aristas vivas y diseñada para un uso prolongado. Idónea para la educación colaborativa. Se entrega totalmente montada.

EN

Agora seating, shall we talk about it? Following the values of concept and manufacture that Grau embodies in all its creations. Minimalist and sturdy. Phenolic surface and CDF doors without sharp edges and designed for long use. Ideal for collaborative learning. Supplied fully assembled.

GRAFITO  
GRAPHITE



TURQUESA  
TURQUOISE



OLIVA  
OLIVE



MOSTAZA  
MUSTARD



\* Tiradores puertas / Door handles

NIVELADOR  
HEIGHT-  
ADJUSTABLE  
FOOT



VERSIONES / VERSIONS

Agora C



Agora One



MEDIDAS / MEASUREMENTS \*

\* Todas las medidas son en centímetros / All measurements are in centimetres

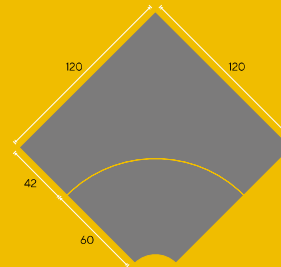
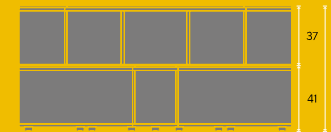
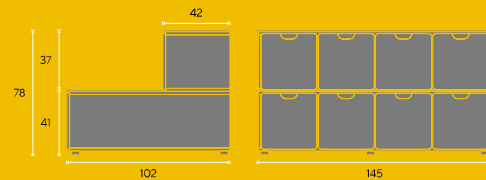

# Cadi

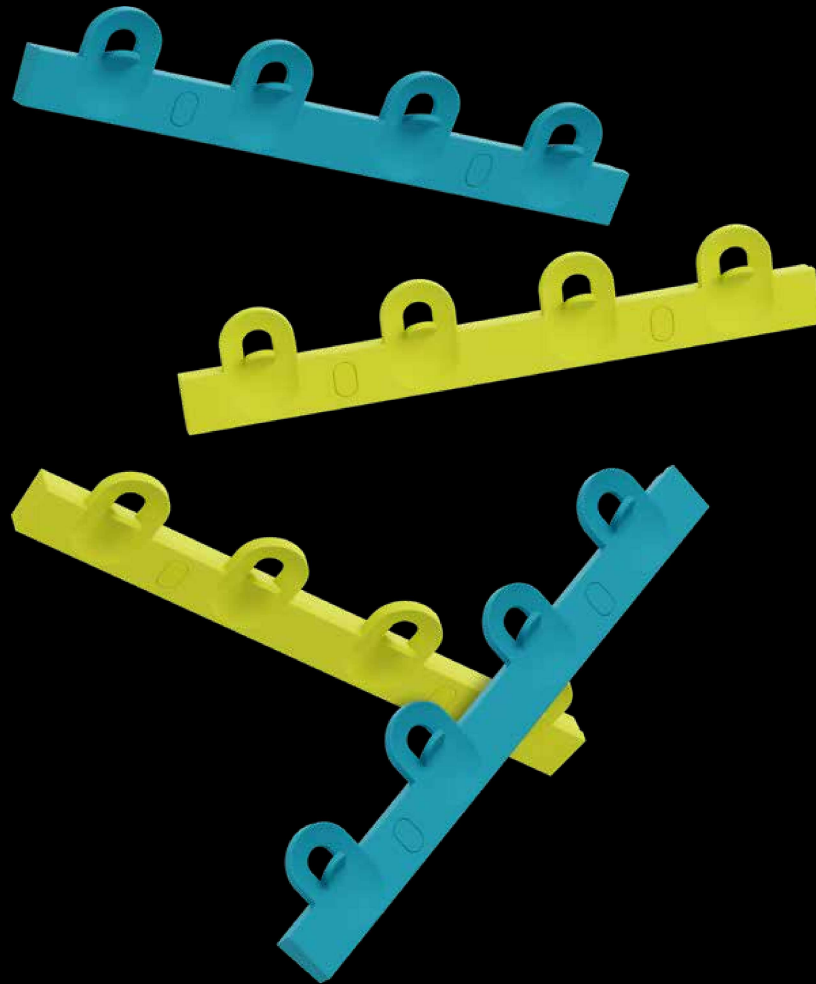

GRAFITO  
GRAPHITE

TURQUESA  
TURQUOISE

OLIVA  
OLIVE

MOSTAZA  
MUSTARD

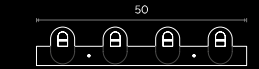

\* Todas las medidas son en centímetros / All measurements are in centimetres

## Cadi Plus

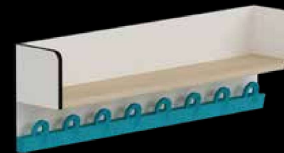

Percha Cadi doble con estante superior portaobjetos. / Cadi coat hooks with shelf above.

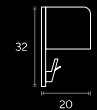

### ACOPLAMIENTO CADI LINKING CADI

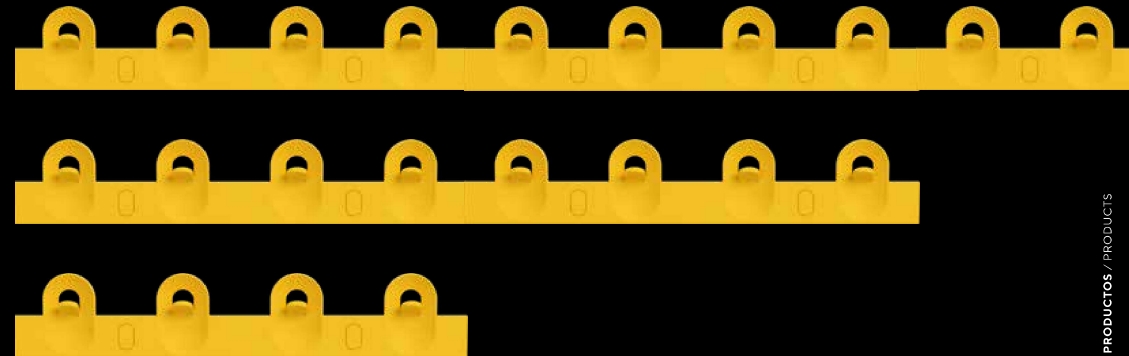

### ACOPLAMIENTO CADI PLUS LINKING CADI PLUS



ES

La percha Cadi, orden con estilo propio. Siguiendo los valores de concepción y fabricación que Grau impregna en todas sus creaciones. Colores armónicos. Dobles ganchos sin aristas vivas y diseñada para un uso prolongado. Versátil para la educación colaborativa o tradicional. Se entrega totalmente montada.

EN

Cadi coat hooks, order with its own style. Following the values of concept and manufacture that Grau embodies in all its creations. Harmonious colours. Double hooks with no sharp edges and designed for long use. Versatile for collaborative or traditional learning. Supplied fully assembled.

DOS GANCHOS  
EN UNO  
TWO HOOKS IN  
ONE



# Productos *Products*

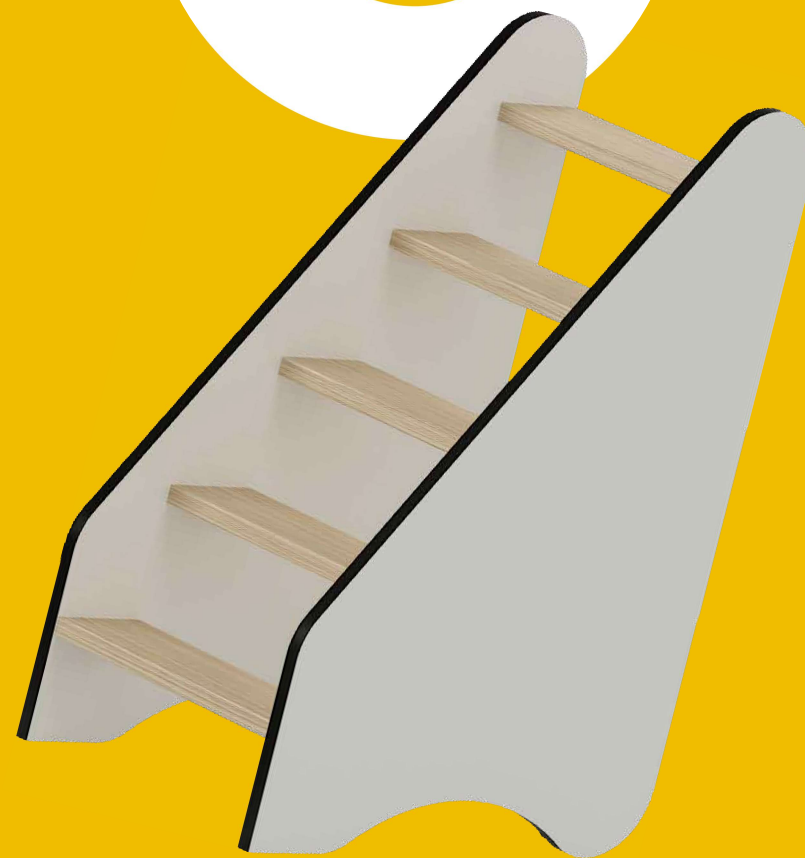

Infantil — *Infants*



# Kiddy R & G

MESA / TABLE

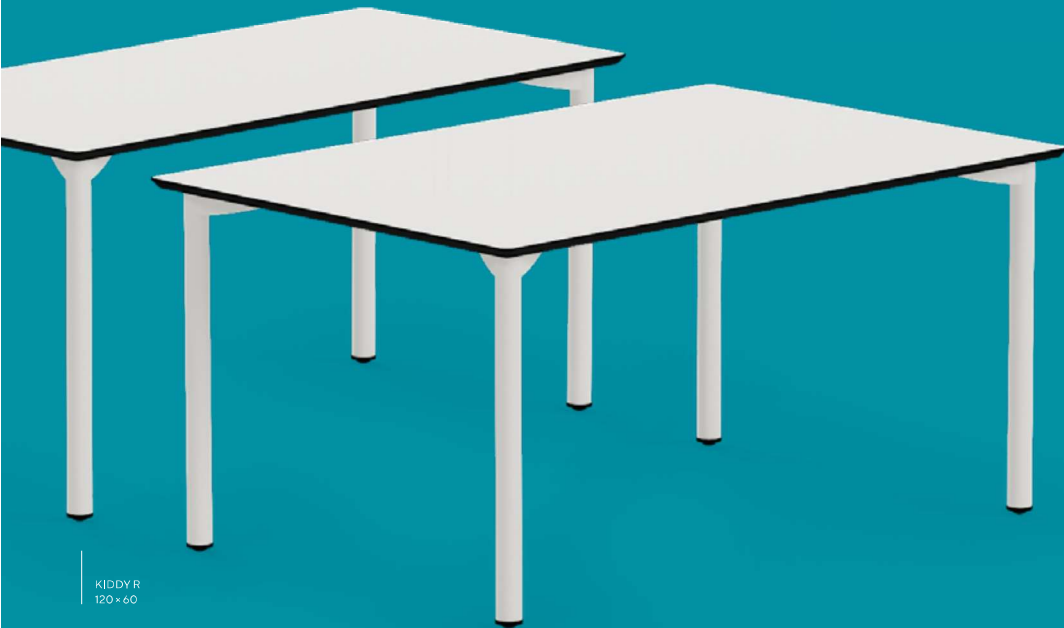

KIDDY R  
120 x 60

KIDDY G  
120 x 80

ES

Mesas Kiddy, creando pequeños grandes proyectos. Siguiendo los valores de concepción y fabricación que Grau impregna en todas sus creaciones. Minimalistas y robustas con distintas formas. Sin aristas vivas y diseñadas para un uso prolongado. Idóneas para la educación infantil colaborativa. Se entregan totalmente montadas.

EN

Kiddy tables, creating little big projects. Following the values of concept and manufacture that Grau embodies in all its creations. Minimalist and sturdy and in different shapes. No sharp edges and designed for long use. Ideal for collaborative learning in infants. Supplied fully assembled.

ACABADOS / FINISHES



CDF BLANCO / WHITE CDF (16.4mm)  
Fibras de densidad compacta / Compact density fibres



PATAS CON PLETINAS METÁLICAS SOLDADAS / LEGS WITH WELDED METAL PLATES (Ø40x1.5mm)  
Pintura en pols epoxi blanc RAL9010 microtexturat / Microtexture white epoxy powder coating RAL9010

\*MEDIDAS / MEASUREMENTS

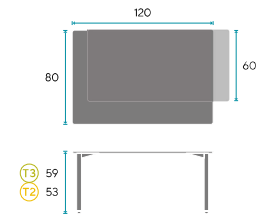

VERSIONES / VERSIONS

Kiddy T

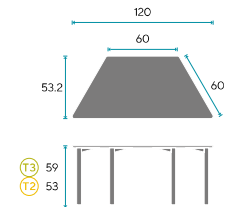

Kiddy C

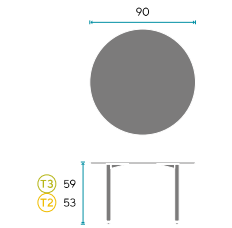

Kiddy E

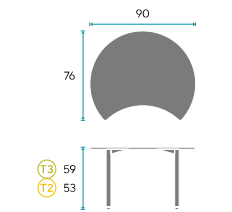

Kiddy SC

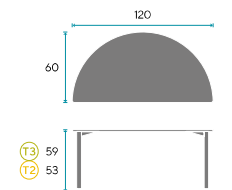

\* Todas las medidas son en centímetros / All measurements are in centimetres

# Kiddy M

ES

Mesa Kiddy M, no resta espacio. Siguiendo los valores de concepción y fabricación que Grau impregna en todas sus creaciones. Minimalista y plegable contra la pared. Sin aristas vivas y diseñada para un uso prolongado. Idónea para la educación colaborativa y para el comedor. Se entrega totalmente montada.

EN

The Kiddy M table, it doesn't take up any space. Following the values of concept and manufacture that Grau embodies in all its creations. Minimalist and can be folded against the wall. No sharp edges and designed for long use. Ideal for collaborative learning and in the dining hall. Supplied fully assembled.



ACABADOS / FINISHES



CDF BLANCO / WHITE CDF  
(16.4mm)  
Fibras de densidad compacta /  
Compact density fibres

CARACTERÍSTICAS / FEATURES

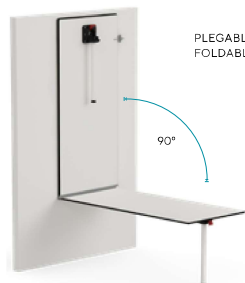

PLEGABLE  
FOLDABLE

90°

\* MEDIDAS / MEASUREMENTS

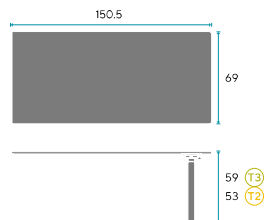

\* Todas las medidas son en centímetros / All measurements are in centimetres

KIDDY R & G

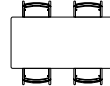

KIDDY T

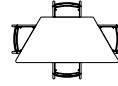

KIDDY E

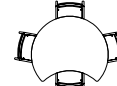

KIDDY SC

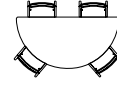

2 x6

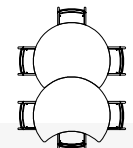
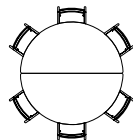
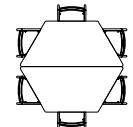

2 x7

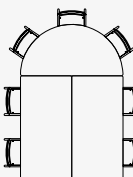

2 x8

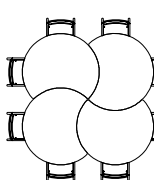
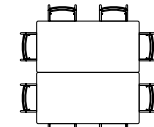

2 x9

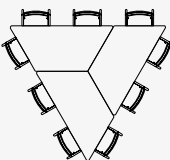
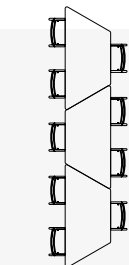

2 x10

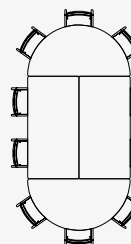
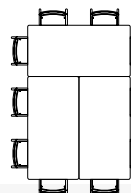
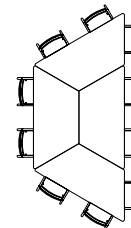

2 x12

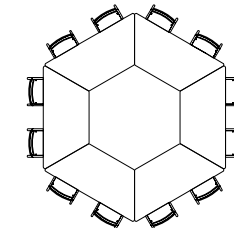

2 x16

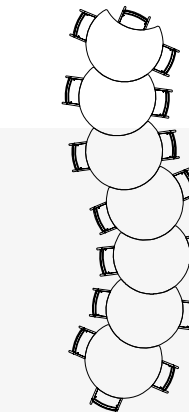

2 x19

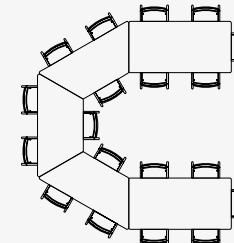

COMBINABLE  
CON /  
COMBINABLE  
WITH

KIDDY R & G  
KIDDY T  
KIDDY E  
KIDDY SC

# Kiddy 45, 59, 95 & Step

ES

Complementos Kiddy, siempre útiles. Siguiendo los valores de concepción y fabricación que Grau impregna en todas sus creaciones. Minimalistas, robustos y con acabados neutros nórdicos, en que los colores los aporta el material escolar. Casillero mural, cambiador, escalera y carro con ruedas. Diseñados para un uso prolongado. Se entregan totalmente montados.

EN

Totally Kiddy, always useful. Following the values of concept and manufacture that Grau embodies in all its creations. Minimalist, sturdy and in neutral nordic finishes where colour is carried by the school stuff. Wall pigeonhole unit, changing station and wheeled storage unit. Designed for long use. Supplied fully assembled.

Kiddy 45



Kiddy 59



Kiddy 95



Kiddy Step



MEDIDAS / MEASUREMENTS \*

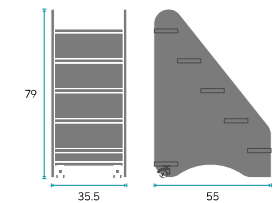
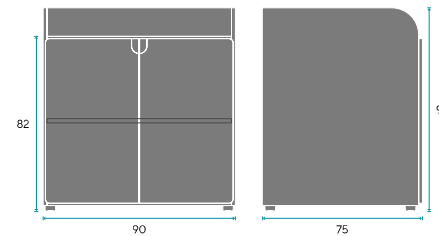
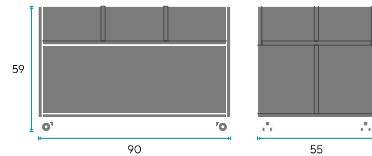
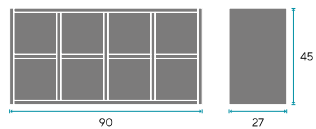

ACABADOS / FINISHES

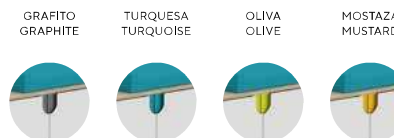

\* Todas las medidas son en centímetros / All measurements are in centimetres

# Espacios *Spaces*

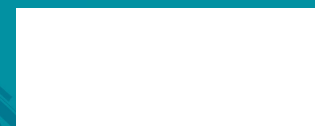



1 Colaborativo —  
Collaborative



2 Colaborativo —  
Collaborative

04. ESPACIOS / SPACES



3 Colaborativo —  
Collaborative



Un mismo espacio, diferentes  
posibilidades — *One space,  
many possibilities*



PRODUCTOS  
UTILIZADOS /  
PRODUCTS USED

SILLA / CHAIR  
SOFT  
SOFT R



PUPITRE / DESK  
ECLIPSE



MESA / TABLE  
TWIST OVAL  
DISC UP



ACCESORIOS / ACCESSORIES  
CADI  
BOX



ALMACENAJE / STORAGE  
DOT 159 P  
AGORA  
AGORA C

Colaborativo —  
Collaborative



SILLA / CHAIR  
SOFT R  
SLIM PROF



PUPITRE / DESK  
PETAL  
PAR  
PILE



MESA / TABLE  
DISC F



ACCESORIOS /  
ACCESSORIES  
CADI  
BOX



ALMACENAJE / STORAGE  
DOT 159 E  
DOT 159 M  
DOT 159 P  
AGORA ONE

Convencional —  
Conventional



SILLA / CHAIR  
SLIM  
SLIM PROF



PUPITRE / DESK  
DESK ONE



MESA / TABLE  
PROF



ACCESORIOS /  
ACCESSORIES  
CADI  
PIZARRA /  
WHITEBOARD



ALMACENAJE / STORAGE  
DOT 197 P  
DOT 197 E

Colaborativo —  
Collaborative



SILLA / CHAIR  
SLIM R  
SLIM PROF



PUPITRE / DESK  
SHARP



ACCESORIOS /  
ACCESSORIES  
CADI  
PIZARRA /  
WHITEBOARD  
BOX



ALMACENAJE / STORAGE  
DOT 82 E  
DOT 82 P

PRODUCTOS  
UTILIZADOS /  
PRODUCTS USED

1

Infantil —  
For infants



PRODUCTOS  
UTILIZADOS /  
PRODUCTS USED

SILLA / CHAIR  
KIDDY VINTA  
PIVOT  
SLIM PROF



MESA / TABLE  
KIDDY SC  
KIDDY R  
PROF



ACCESORIOS /  
ACCESSORIES  
CADI PLUS  
KIDDY 59



ALMACENAJE / STORAGE  
DOT 82 A  
DOT 82 P

2

Infantil —  
For infants

04. ESPACIOS / SPACES



SILLA / CHAIR  
KIDDY COSY  
SLIM PROF



MESA / TABLE  
TWIST OVAL  
DISC UP  
KIDDY E



ACCESORIOS /  
ACCESSORIES  
PIZARRA /  
WHITEBOARD



ALMACENAJE / STORAGE  
DOT 82 A  
DOT 197 M  
DOT 197 P  
AGORA ONE

Biblioteca —  
Library



PRODUCTOS  
UTILIZADOS /  
PRODUCTS USED



SILLA / CHAIR  
WOODY  
PIVOT



MESA / TABLE  
LINE 150  
DISC F



ACCESORIOS /  
ACCESSORIES  
CADI  
KIDDY 59



ALMACENAJE / STORAGE  
DOT 197 E  
DOT 197 R  
AGORA  
AGORA C  
AGORA ONE

Universidad —  
University

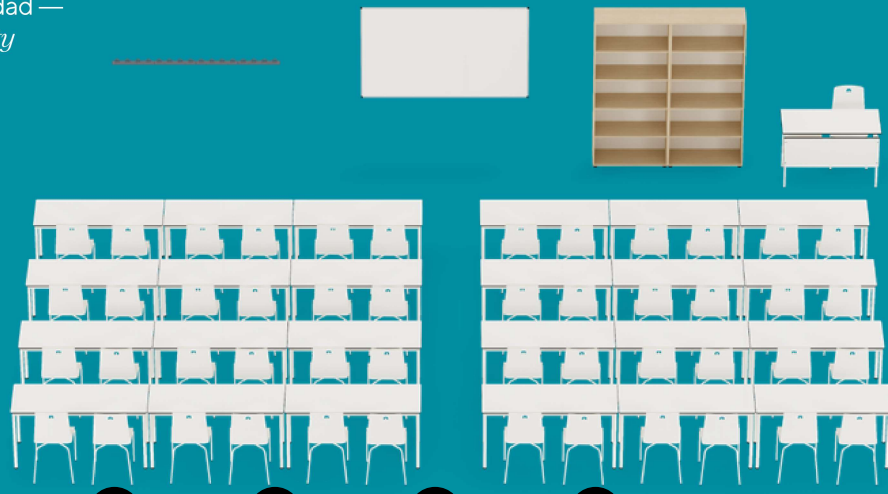

SILLA / CHAIR  
**WOODY**



MESA / TABLE  
**PROF LINE 150**



ACCESORIOS / ACCESSORIES  
**CADI PIZARRA / WHITEBOARD**



ALMACENAJE / STORAGE  
**DOT 197 E**

PRODUCTOS UTILIZADOS / PRODUCTS USED

Lab & Tech —  
Lab & Tech

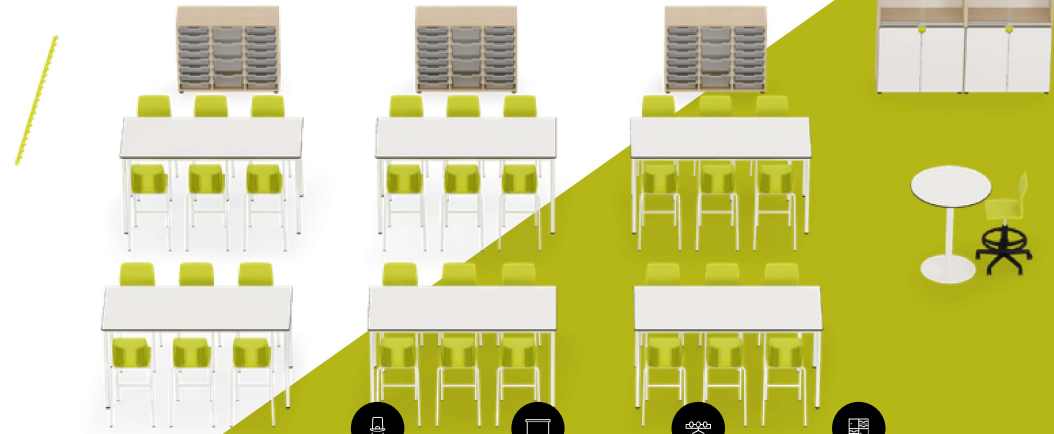

SILLA / CHAIR  
**SLIM F SLIM G**



MESA / TABLE  
**LINE 180 DISC UP**



ACCESORIOS / ACCESSORIES  
**CADI**



ALMACENAJE / STORAGE  
**DOT 197 V DOT 82 A**

Comedor —  
Dining hall

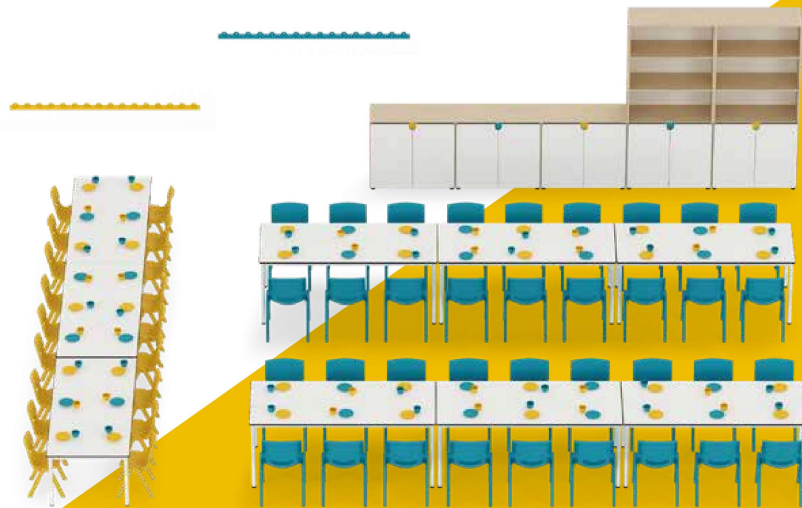

SILLA / CHAIR  
**KIDDY COSY COSY**



MESA / TABLE  
**LINE 120 T3 LINE 180 T6**



ACCESORIOS / ACCESSORIES  
**CADI**



ALMACENAJE / STORAGE  
**DOT 82 P DOT 197 M**

PRODUCTOS UTILIZADOS / PRODUCTS USED

Recepción —  
Reception hall

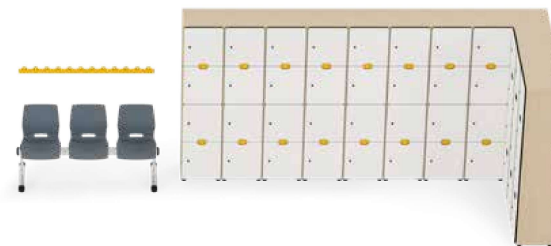

SILLA / CHAIR  
**SLIM B**



ACCESORIOS / ACCESSORIES  
**CADI**



TAQUILLAS / LOCKERS  
**DOT 197 T**



# General *General*

Técnico y Overview — *Specifications  
and Overview*

# Técnico — Specifications

## Tallas y medidas — Sizes and measurements



ES

Todas las tallas y medidas son relativas a las dimensiones funcionales de las sillas y mesas para centros de enseñanza, según la normativa ISO 5970 o UNE-EN 1729-1 (con una tolerancia admisible de  $\pm 1$  cm).

EN

All sizes and measurements are relative to the functional dimensions of chairs and tables for educational establishments in accordance with ISO 5970 or UNE-1729-1 (with an allowed tolerance of  $\pm 1$  cm).

TALLA SIZE	EDAD AGE	CURSO SCHOOL STAGE	ALT. ASIENTO H. CHAIR	ALT. MESA H. TABLE
T8*	+11	SECUNDARIA O SUPERIOR SECONDARY OR ABOVE	65 cm	90 cm
T6	+11	SECUNDARIA O SUPERIOR SECONDARY OR ABOVE	46 cm	76 cm
T5	8—11	PRIMARIA JUNIOR	43 cm	71 cm
T4	6—8	PRIMARIA JUNIOR	38 cm	64 cm
T3	5—6	INFANTIL INFANTS	35 cm	59 cm
T2	3—5	INFANTIL INFANTS	31 cm	53 cm

\* Equivalencia para mesas de trabajo de pie / Equivalent for standing work tables

## Iconografía — Iconography

### CATEGORÍA / CATEGORY



### ESCUELA / SCHOOL

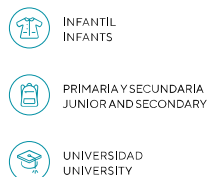

### ÁREAS / AREAS



## 05. TÉCNICO / SPECIFICATIONS

## Materiales — Materials

### Fenólico — PF Resin

ES Panel indivisible, formado por múltiples láminas kraft impregnadas con resina fenólica. Resistencia al rayado y al calor, hidrófugo y fácil de limpiar, resistencia a los productos químicos y alta resistencia a los impactos y a la creación de grietas.

EN Single panel formed of several layers of kraft impregnated with polyphenolic resin. Scratch and heat-resistant; impervious to water and easy to clean, resistant to chemicals and high impact and fissure resistance.

ESPESOR / THICKNESS 12 mm  
DENSIDAD / DENSITY 1410 Kg/m<sup>3</sup>

### CDF — CDF

Panel indivisible, formado por fibras de densidad compacta. Fácil de limpiar, buena resistencia a la humedad y alta resistencia a los impactos y a la creación de grietas.

Single panel formed of compact density fibre. Easy to clean, good damp resistance and high impact and fissure resistance.

ESPESOR / THICKNESS 16.4 mm  
DENSIDAD / DENSITY 1000 Kg/m<sup>3</sup>

### Melamina — Melamine

Panel de aglomerado con acabado melamínico a dos caras. Opcional: melamina rotulable con acabado liso brillante.

Aglomerate wood with melamine on both sides. Optional: writeable melamine with smooth brilliant finish.

ESPESOR / THICKNESS 19 mm  
DENSIDAD / DENSITY 680 Kg/m<sup>3</sup>  
CANTEADO PVC RÍGIDO / RIGID PVC EDGING 1.2 mm

### Estructuras — Structures

ES Fabricadas con tubo de acero laminado en frío, de grosor desde 1.5 mm a 3 mm según modelo. Estructuras soldadas.

EN Made from cold-laminated steel tubing of thicknesses 1.5 mm – 3 mm depending on product. Welded structures.

### Asientos y respaldos — Seats and chair backs (Vinta + Woody)

Tablero contrachapado con láminas de madera de haya. Lámina exterior de Laminado de Alta Presión (HPL), encolado con alta frecuencia.

Panel in beech ply. Surface in High Pressure Laminate (HPL) with high frequency gluing.

### Plástico — Plastic

Polipropileno reforzado (PP).

Reinforced polypropylene (PP).

### Pintura — Paint

ES Todas las estructuras de hierro están pintadas con polvo tipo Epoxi-Poliéster, color blanco RAL9010 microtexturizado, mediante túnel automatizado: desengrase, fosfatado, lavado, pasivado, secado, recubrimiento en polvo electrostático y polimerización final para garantizar una máxima adhesión y durabilidad de la pintura.

EN All steel structures are finished with microtextured RAL9010 white Epoxy-Polyester powder coating in an automated powder coating tunnel: degreased, phosphate-washed, washed, passivised, dried, final coat of polymerised electrostatic powder to ensure maximum adhesion and durability of the finish.

# Overview

Pupitres — Desks



Desk One — p.34



Desk Two — p.35



Eclipse — p.36



Petal — p.38



End — p.40



Par — p.42



Sharp — p.44



Pile — p.46



Box — p.48

Mesas — Tables



Twist Oval — p.52



Twist R — p.53



Disc Up — p.54



Line — p.56



Disc F — p.58



Prof — p.58



Duo — p.58



Pizarra / Whiteboard — p.59

Sillas — Chairs



Soft — p.62



Soft R — p.63



Soft F — p.63



Slim — p.64



Slim R — p.65



Slim Up — p.65



Slim P — p.65



Slim F — p.66



Slim G — p.67



Slim Prof — p.67



Slim B — p.67



Vinta — p.68



Kiddy Vinta — p.69



Cosy — p.70



Kiddy Cosy — p.71



Woody — p.72



Pivot — p.73

Almacenaje — Storage



Dot 82 E — p.76



Dot 82 P — p.76



Dot 82 A — p.76



Dot 82 B — p.77



Dot 82 C — p.77



Dot 82 F — p.77



Dot 159 E — p.78



Dot 159 M — p.78



Dot 159 P — p.78



Dot 159 A — p.79



Dot 159 C — p.79



Dot 197 E — p.80



Dot 197 M — p.80



Dot 197 V — p.80



Dot 197 P — p.81



Dot 197 R — p.81



Dot 197 T — p.81



Agora — p.82



Agora C — p.83



Agora One — p.83



Cadi — p.84



Cadi Plus — p.85



Bandejas / Trays — p.77

Infantil — Infants



Kiddy R — p.88



Kiddy G — p.88



Kiddy T — p.89



Kiddy C — p.89



Kiddy E — p.89



Kiddy SC — p.89



Kiddy M — p.90



Kiddy 45 — p.92



Kiddy 59 — p.92



Kiddy 95 — p.93



Kiddy Step — p.93